

Identifying and Quantifying Printed Circuit Board Inductance

Todd H. Hubing, Thomas P. Van Doren, and James L. Drewniak
 University of Missouri-Rolla
 Rolla, MO 65401

Abstract

The concepts of inductance and partial inductance play a key role in printed circuit board (PCB) modeling. The inductance of the signal path is an important parameter in high-speed signal integrity calculations. Delta_I noise modeling, crosstalk calculations, and common-mode source identification all rely heavily on accurate estimations of the partial inductance associated with traces, vias, and signal return paths on printed circuit boards. This paper begins by identifying and quantifying the parameters that affect the inductance of typical PCB geometries. Closed-form equations are provided for estimating the partial inductances of simple trace, via, and ground plane configurations. Finally, the issue of current "crowding" around via connections in planes and its affect on the partial inductance of the plane is addressed.

Inductance

At high frequencies the distributed inductance, capacitance, and resistance of traces, vias, and planes on a printed circuit board can be just as important as the lumped parameters of the circuit components. Traditionally, the inductance of various circuit board geometries has been the most difficult parameter to quantify. Unlike capacitance and resistance, inductance is a property of a closed current path.

Inductance is defined as a ratio of the total magnetic flux that couples (passes through) a closed path to the amplitude of the current that is the source of the magnetic flux,

$$L_{ij} = \frac{\Psi_{ij}}{I_i} \text{ henries.} \quad (1)$$

If a wire is configured in a closed loop, the inductance will be a function of the loop geometry as well as the shape and dimensions of the wire itself.

Partial Inductance

Although inductance is only defined for complete loops, it is often advantageous to assign *partial inductance* values to sections of a current loop. This concept is useful for determining how the overall inductance of a current path is affected by individual segments of the path. For example, to lower the overall inductance of a particular geometry, one might focus attention on the segments of the path with the highest partial inductance. The concept of partial inductance is also useful for estimating the voltage *dropped* across part of a circuit due to inductance. This idea must be applied with care however, since voltage drop or potential difference is not uniquely defined in the presence of time-varying fields.

We would like to define partial inductance such that for a current path with n segments,

$$L_{total} = L_{\text{partial segment 1}} + L_{\text{partial segment 2}} + \dots + L_{\text{partial segment n}}. \quad (2)$$

Since L_{total} is the ratio of the total flux coupling the loop to the current in the loop, and since the current in each segment of a static current loop is equal, we can define the partial inductance of a particular segment as the ratio of the flux coupling the loop due to the current in that segment divided by the current,

$$L_{\text{partial segment } i} = \frac{\Psi_i}{I} = \frac{\text{flux due to segment } i \text{ that couples loop}}{\text{amplitude of current in segment } i}. \quad (3)$$

It is important to note that the calculation of partial inductance for each segment still requires a knowledge of the entire current path.

Therefore, the same wire segment located in two different loops will, in general, have a different partial inductance.

Self and Mutual Partial Inductance

Ruehli [1] developed a concept called *self partial inductance* that is defined for a given segment of a loop independent of the location or orientation of any other loop segment. For a straight wire segment with a finite wire radius as shown in Figure 1, a nominal rectangular loop is defined that is bounded by the wire segment on one side and infinity on the other side. Two lines perpendicular to the wire segment and extending from the ends of the segment to infinity form the other two sides of the loop. The self partial inductance is the ratio of the net flux passing through this loop to the current on the wire segment (in the absence of all other segments and currents). Ruehli also defined a *mutual partial inductance* existing between two wire segments. Mutual partial inductance can be viewed as the net flux from one segment that passes through a second segment's infinite rectangular loop divided by the current in the first segment. Referring to Figure 2, it is clear that for two parallel segments the quantity $L_{11}-L_{12}$ (i.e. the self partial inductance minus the mutual partial inductance) is equal to the total flux coupling the loop due to segment 1 divided by the current in segment 1. In other words, $L_{11}-L_{12}$ is the part of the loop inductance due to segment 1. In general, we can define the partial inductance of a segment i to be its self inductance plus or minus the mutual inductances between segment i and all other loop segments,

$$L_i = L_{ii} \pm \sum_{\substack{j=1 \\ j \neq i}}^n L_{ij}. \quad (4)$$

Whether the mutual inductance is added or subtracted is determined by the relative orientation of the current on the two segments. If the flux from both segments passes through the infinite rectangular loop area in the same direction, the sign is positive. For segments with current flowing in opposite directions as shown in Figure 2, the sign is negative.

Conductors of arbitrary cross-section

Ruehli's definitions of self and mutual partial inductance assume that the current is uniformly distributed on the surface of a thin wire filament. In order to calculate the partial inductance of other conductor shapes, these conductors must be viewed as being composed of

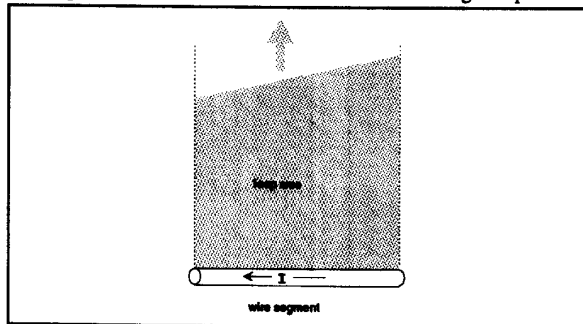

Figure 1: Loop area used to define self partial inductance

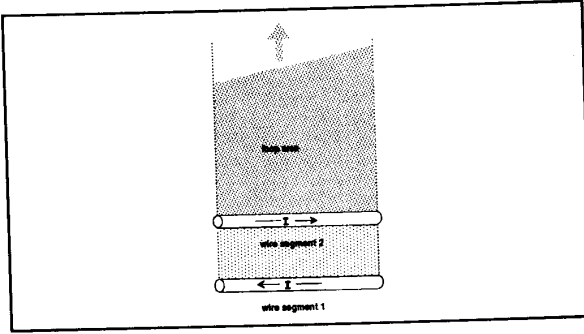

Figure 2: Loop area defining mutual partial inductance

many thin filaments. For example, a wide flat printed circuit board trace might be modeled as several filaments side by side as shown in Figure 3. Analysis of the circuit containing this trace would require all of these filaments and their self and mutual partial inductances to be accounted for.

Although analysis of configurations like the one in Figure 3 can be done on the computer in a straightforward manner, it is also helpful to have a more intuitive feel for the effect that different conductor shapes have on the partial inductance. For the configuration in Figure 3, the partial inductance associated with each filament is the self partial inductance of that filament plus the mutual partial inductance between that filament and all the other filaments in the trace minus the partial inductance of that filament with the other parts of the loop,

$$L_{\text{filament}} = L_{ii} + \sum_{\substack{j=1 \\ j \neq i}}^n L_{ij} \pm \sum_{\substack{j=n+1 \\ j \neq i}}^m L_{ij} \quad (5)$$

Since the filaments in the same trace are tightly coupled, their mutual partial inductances will be high (but still necessarily less than the self partial inductance). Therefore, the partial inductance of each filament will be nearly n times greater when it is located near the other filaments than it would be if it were isolated from the others. However, the partial inductance of the wide trace overall is actually the parallel combination of all of the filament partial inductances. Assuming each filament had approximately the same partial inductance, the trace partial inductance would be the filament partial inductance divided by n . Widening the trace, lowers the partial inductance because the additional parallel inductance more than compensates for the added self partial inductance of each filament. A computer analysis of this configuration would also show that the partial inductance of the outer filaments is slightly lower than that of the inner filaments. As a result, more of the current flows on the outside edge of the trace.

It is important to note that the concept of *self partial* inductance is only defined for the individual wire filaments and not for the wide trace. On the other hand, a *partial* inductance can be defined for the wide trace, but only if the current return path is specified.

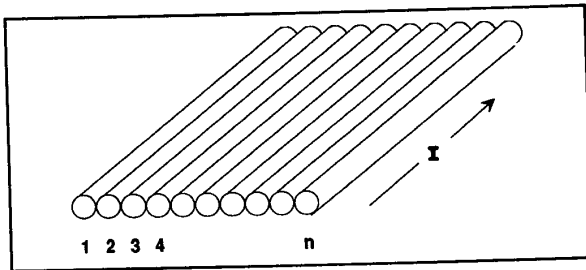

Figure 3: Wide trace modeled with wire filaments

Partial inductance of short wires or vias

Consider the pair of short wires with length h and radius a that are separated by a distance s illustrated in Figure 4. For a given loop area, the partial inductance of each wire is the ratio of the flux coupling to the current in the wire. Placing one of the wire segments on the z -axis of a cylindrical coordinate system as shown, the expression for the magnetic field due to a current I flowing in the segment is,

$$H(r, \phi, z) = \frac{I}{4\pi r} \left[\frac{h-z}{\sqrt{r^2 + (h-z)^2}} + \frac{z}{\sqrt{r^2 + z^2}} \right] \hat{\phi} \quad (6)$$

The total flux passing through the loop indicated in Figure 4 is,

$$\Psi = \int_0^s \int_a^h \mu_0 H \phi(r, \phi, z) dz dr = \frac{\mu_0 I}{2\pi} \left[-s + \sqrt{h^2 + s^2} - h \ln \left(\frac{h + \sqrt{h^2 + s^2}}{s} \right) - h + h \ln \frac{2h}{a} \right] \quad (7)$$

The partial inductance of the wire is the total flux Ψ divided by the current I . If the separation s is much greater than the length h , the expression for the partial inductance reduces to,

$$L_{\text{via}} = \frac{\mu_0 h}{2\pi} \ln \left(\frac{2h}{a} \right) H/m \quad (s \gg h) \quad (8)$$

Note that when the separation s is large relative to the length of the wire or via, the partial inductance is independent of the separation.

Partial inductance of long wires or vias between planes

Vias between planes on a multilayer printed circuit board can often be treated in the same manner as long wires. This is due to the fact that the images of the via in the planes cause the magnetic field between the planes to resemble the field created by a long wire. This field is given by the expression,

$$H = \frac{I}{2\pi r} \hat{\phi} \quad (9)$$

where, in the case of the vias between planes, it is assumed that I is the conduction current on the via and that the displacement current between the planes can be neglected.

Referring to Figure 5, if the loop area is defined as the region bounded by the vias and the planes, the expression for the flux coupling this loop is,

$$\Psi = \int_0^s \int_a^h \frac{\mu_0 I}{2\pi r} dz dr = \frac{\mu_0 I h}{2\pi} \ln \left(\frac{s}{a} \right) \quad (10)$$

The partial inductance of the wire or via is then,

$$L_{\text{via between planes}} = \frac{\mu_0 h}{2\pi} \ln \left(\frac{s}{a} \right) H/m \quad (11)$$

Note that unlike vias that are not between planes, the partial inductance of vias between planes is a function of the separation s .

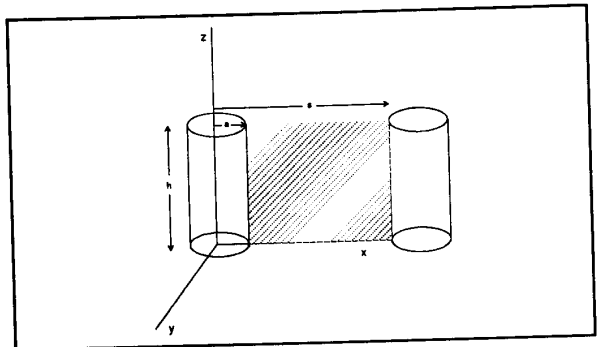

Figure 4: Short wire or via geometry

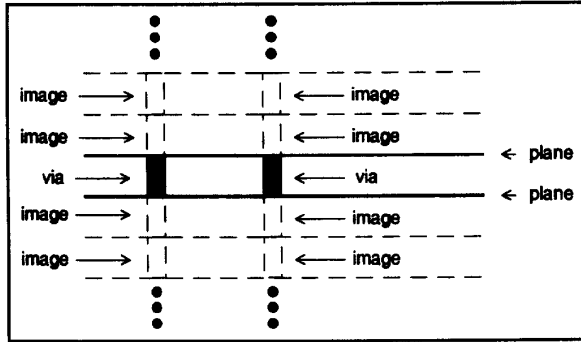

Figure 5: Vias between conducting planes

Partial inductance of a narrow trace above a plane

The partial inductance of a thin narrow trace above a ground plane can be calculated using image theory and the formula for the magnetic field from a long wire, Equation (9). For a trace of effective radius a that is a height h above a plane of width w ($w \gg h \gg a$) as shown in Figure 6, the approximate flux passing between the trace and the plane is,

$$\Psi \approx \int_a^{2h} \frac{\mu_0 I}{2\pi r} dr = \frac{\mu_0 I}{2\pi} \ln\left(\frac{2h}{a}\right) \quad (12)$$

The partial inductance of the trace is therefore,

$$L_{\text{trace}} = \frac{\mu_0}{2\pi} \ln\left(\frac{2h}{a}\right) H/m \quad (13)$$

Note that the partial inductance of the trace equals the total inductance. This is because applying image theory was equivalent to assuming that the plane had infinite width. Since no flux lines wrap around an infinite plane, it has zero partial inductance. All lines of flux wrap around the trace and therefore the partial inductance of the trace equals the total inductance.

Finite values of w do not have a significant effect on the total flux wrapping around the trace provided $w \gg h$. Therefore, the approximate expression for the trace partial inductance in Equation (13) is valid as long as the plane is significantly wider than the trace height and trace radius.

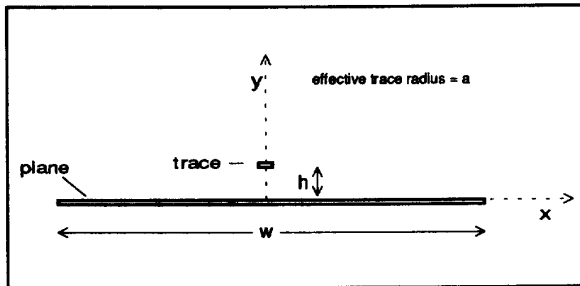

Figure 6: Narrow trace above a plane

Partial inductance of a plane

While the partial inductance of the plane in Figure 6 is always much smaller than the trace partial inductance, it can not always be neglected. The small voltage dropped across the plane may be a significant source of unwanted coupling.

In order to calculate the plane partial inductance, we begin by noting that the current density induced on the surface of the plane must equal the tangential magnetic field strength due to the current on the trace.

Using the coordinate system indicated in Figure 6, the induced current density must be,

$$J = \frac{Ih}{2\pi(x^2 + h^2)} \hat{z} \quad (14)$$

The total current induced on the top of the plane is therefore,

$$I_{\text{induced}} = \int_{-w/2}^{w/2} J_z dx = \int_{-w/2}^{w/2} \frac{Ih}{2\pi(x^2 + h^2)} dx \quad (15)$$

The induced current does not produce lines of flux that wrap around the plane and is therefore not included in calculation of the partial inductance of the plane. Note however, that there is a difference between the total current on the plate and the induced current,

$$I - I_{\text{induced}} = 2 \int_{-w/2}^{w/2} \frac{Ih}{2\pi(x^2 + h^2)} dx = \frac{I}{\pi} \left[\frac{\pi}{2} - \tan^{-1}\left(\frac{w}{2h}\right) \right] \quad (16)$$

This remaining current must distribute itself on the plane in a manner that does not create any additional magnetic field within the metal interior of the plane. The problem of calculating the plane partial inductance is now found to be equivalent to the problem of calculating the partial inductance of the wide trace in Figure 3. Half of the remaining current flows on the top of the plane and the other half on the bottom.

In order to get an expression for the magnetic flux near the center of the plane, we make the approximation that the current $I - I_{\text{induced}}$ is uniformly distributed on both sides of the plane, which is a valid assumption at points away from the edges. The magnetic flux just above the surface of the plane (due to the current $I - I_{\text{induced}}$) is then,

$$\Psi \approx \mu_0 H_x h = \mu_0 \frac{(I - I_{\text{induced}})}{2} w = \frac{\mu_0 I h}{2\pi w} \left[\frac{\pi}{2} - \tan^{-1}\left(\frac{w}{2h}\right) \right] \quad (17)$$

The partial inductance of the plane is therefore,

$$L_{\text{plane}} \approx \frac{\mu_0 h}{2\pi w} \left[\frac{\pi}{2} - \tan^{-1}\left(\frac{w}{2h}\right) \right] = \frac{\mu_0}{\pi} \left(\frac{h}{w}\right) \left[\frac{\pi}{2} - \tan^{-1}\left(\frac{w}{2h}\right) \right] H/m \quad (18)$$

In order to verify this expression, a two-dimensional field solver was used to calculate the total inductance of a 10 mil trace spaced 10 mils over a wide plane. The partial inductance of the trace was determined using Equation (13) and the partial inductance of the plane was calculated as the total inductance minus the trace partial inductance. The results are plotted in Figure 7. The agreement between the numerical results and the closed form expression in Equation (18) is very good provided the width of the plane is significantly greater than the width of the trace.

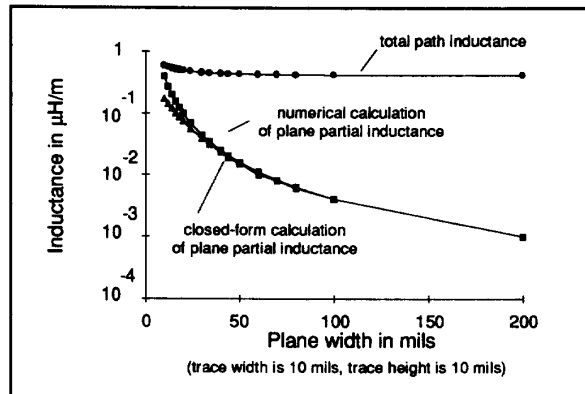

Figure 7: Calculation of plane partial inductance

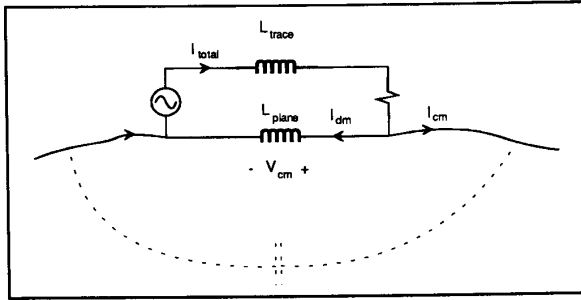

Figure 8: Common mode current radiation model

Trace over plane as a common mode voltage source

The configuration illustrated in Figure 8 is often used to illustrate how the partial inductance of a plane creates a voltage that drives common mode current on cables. However, the plane partial inductance indicated in this figure is not the same as the plane partial inductance calculated using Equation (18). Any voltage drop calculated using Equation (18) only affects currents flowing in the trace/plane path. The common mode current path indicated in Figure 8 does not involve the trace.

The inductance indicated in Figure 8 is actually a *partial mutual inductance* (not to be confused with mutual partial inductance). Where we define partial mutual inductance based on the flux wrapping around one part of a current loop that couples to another loop involving the same part. For the trace over plane geometry in Figure 6, the calculation of the partial mutual inductance of the plane and the radiation current path begins in the same manner as before. The calculation of $I - I_{induced}$ is unchanged, but in this case the loop area is the region from the center of the plane to $y = -\infty$. The expression for the flux density in this region is given by,

$$\Psi = \int_0^{-\infty} \mu_0 H_x dy \quad (19)$$

Since the magnetic field for large values of y falls off as $1/r$, the calculated inductance per unit length will be infinite (just as it would be for a wire of infinite length). However, if we assume that the plane's length is approximately equal to its width, we can approximate the total flux to be that of the uniform flux density near the plane times w ,

$$\Psi = \int_0^w \mu_0 \frac{(I - I_{induced})}{2} dy \approx \frac{\mu_0 I}{\pi} \left[\frac{\pi}{2} - \tan^{-1} \left(\frac{w}{2h} \right) \right] \approx \frac{\mu_0 h I}{\pi w} \quad (20)$$

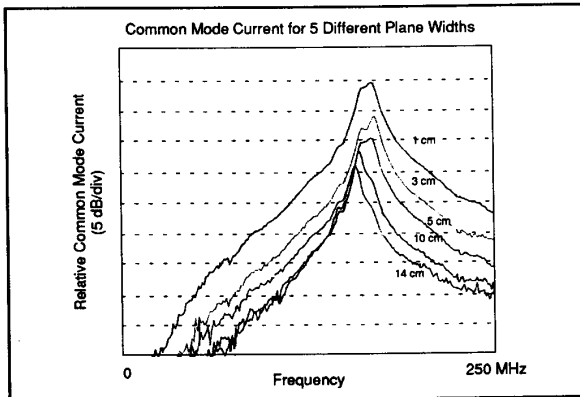

Figure 9: Measured CM current for different plane widths

and the partial mutual inductance of the plane is therefore,

$$L_{plane-to-CM} = \frac{\mu_0 h}{\pi w} H_{/m} \quad (21)$$

Note that while the expression for the partial inductance of the plane in Equation (18) is inversely proportional to the *square* of the width of the plane, the inductance in Equation (21) is inversely proportional to the width of the plane. A measurement of common mode current induced in a wire-over-plane configuration is presented in Figure 9. The test setup is described in another paper [2] printed in these proceedings. These results support the conclusion that the induced common mode current and the partial mutual inductance of the plane are inversely proportional to the plane width for a configuration of these dimensions.

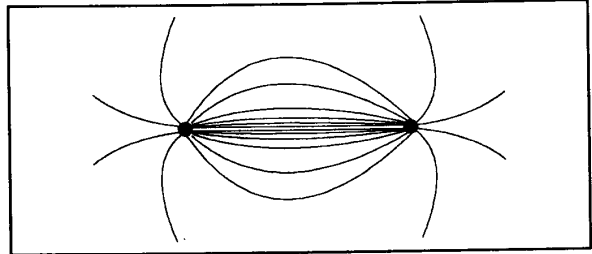

Figure 10: Current distribution between vias on a plane

Effect of current crowding on planes near vias

In many cases, the two-dimensional models used in the previous sections can be applied to real three-dimensional printed circuit board geometries by simply multiplying the per-unit-length values of inductance by the length of the geometry. However, if the current distribution is perturbed (e.g. by a gap in the plane) there may be additional inductance. As Figure 10 illustrates, the current flowing between two vias attached to a plane is generally more concentrated in the vicinity of the vias. There is a tendency to conclude that this concentration of the current results in a higher partial inductance for the plane. However, in most cases, this conclusion is incorrect. To see this, recall that the partial inductance of any piece of the circuit depends on the amount of flux wrapping around that piece. Note that the magnetic field directly above the plane is perpendicular to the surface current. If the via is far from the edge of the plane, the flux associated with the concentrated current density surrounds the via, not the plane. Therefore the partial inductance of the *via* is influenced by this concentration of current, not the partial inductance of the plane. This is consistent with the observation that changes in the geometry of the via affect the current distribution in this region, while changes in the geometry of the plane do not.

If the via is near a corner of the plane, the concentrated current density around the via will cause additional lines of flux to wrap around the plane. However, in most practical situations, this effect is unlikely to be strong enough to have a significant effect on the overall partial inductance of the plane.

References

- [1] A.E. Ruehli, "Inductance calculations in a complex integrated circuit environment," IBM J. Res. Develop., vol. 16, no. 5, pp. 470-481, Sept. 1972.
- [2] J. Drewniak et al., "Fundamental mechanisms of common-mode radiation from printed circuit boards," Proceedings of the 1994 National Symposium on EMC, August, 1994.